

DJI MATRICE 100



In the Box

Standard Package

Check that all of the following items are in your package. If any items are missing, please contact DJI or your local dealer.

Center Frame × 1 (with Battery Compartment)

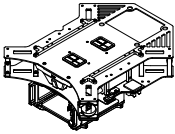

Frame Arm × 4



Quick-Release Propeller Pair × 3

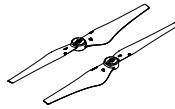

Remote Controller × 1

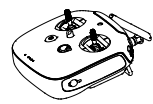

Mobile Device Holder × 1



Intelligent Flight Battery × 1 (TB47D)



Battery Charger × 1

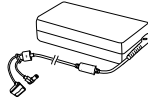

Power Cable × 1



Micro-USB Cable × 1



GPS Module × 1



GPS Bracket Set × 1



Arm Fastener × 4



Expansion Bay × 2

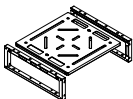

Gimbal Mounting Plate × 1

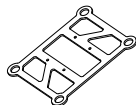

Damper × 4



XT30-XT60 Cable × 1

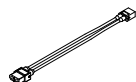

UART Cable x 1



2.0 Hex Key x 1

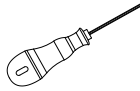

Slotted Screwdriver x1

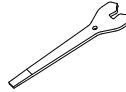

Double-Sided Tape



Screws



M2.5x5, M2.5x8,
M3x8 (self-tapping),
M3x5, M3x5.5

Manuals



DJI Matrice 100 In the Box
DJI Matrice 100 Disclaimer and Safety Guidelines
DJI Matrice 100 Intelligent Flight Battery Safety Guidelines

Optional Items

ZENMUSE X3

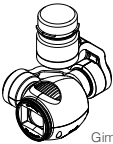

Gimbal & Camera



ND Filter

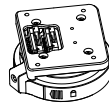

Gimbal Lock

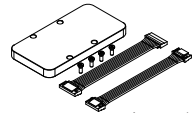

Accessories

Intelligent Flight Battery
(TB47D/TB48D)

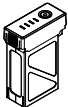

Battery Compartment

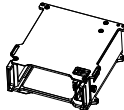

Expansion Bay

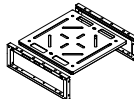

Guidance Bracket Set



Visit the DJI Online Store for more optional items.
<http://store.dji.com>



Exploded View

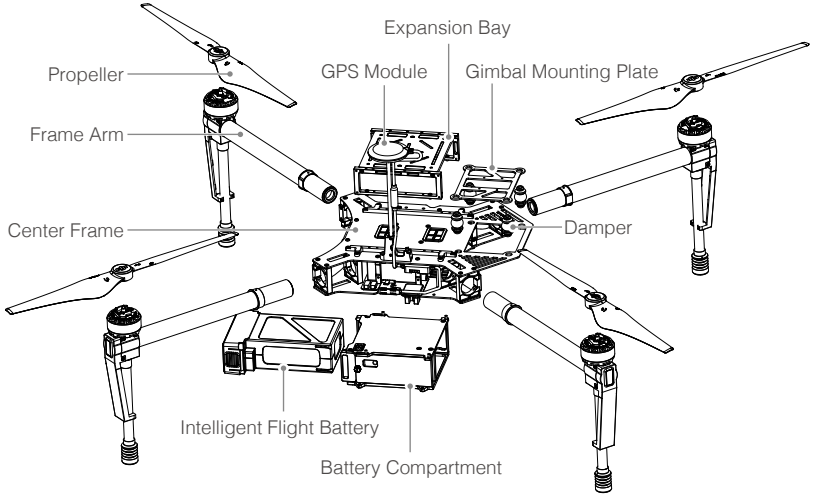

Assembled View

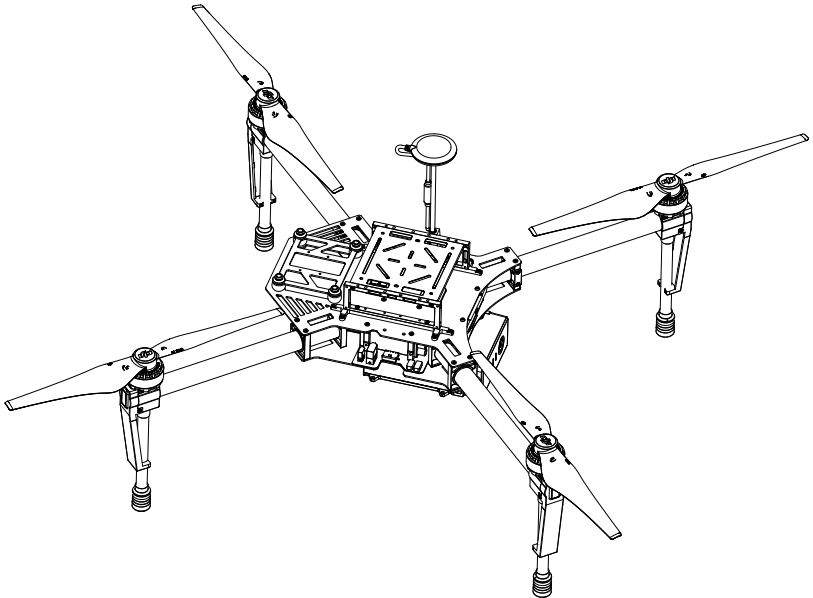

For more product information, visit the DJI Matrice 100 product page and download the *DJI Matrice 100 User Manual*.

<https://dev.dji.com/products/flying-platforms/matrice-100>



If you have any questions about this document, please contact DJI by sending a message to **DocSupport@dji.com**.